



SV-A300

ESSENTIAL GLASS

ESSENTIAL GLASS SV-A300

SV-A300 ES LA SOLUCIÓN PARA PUERTAS CORREDERAS SUSPENDIDAS DE ALTA CALIDAD.

Ideal para divisiones y puertas de uso doméstico o comercial de gran formato.

1. Soportan un máximo de 300kg por hoja respectivamente.
2. Roldanas con rodamiento a bolas.
3. Posibilidad de tapetas embellecedoras cubre-pinzas.
4. No se requiere mecanización del vidrio.

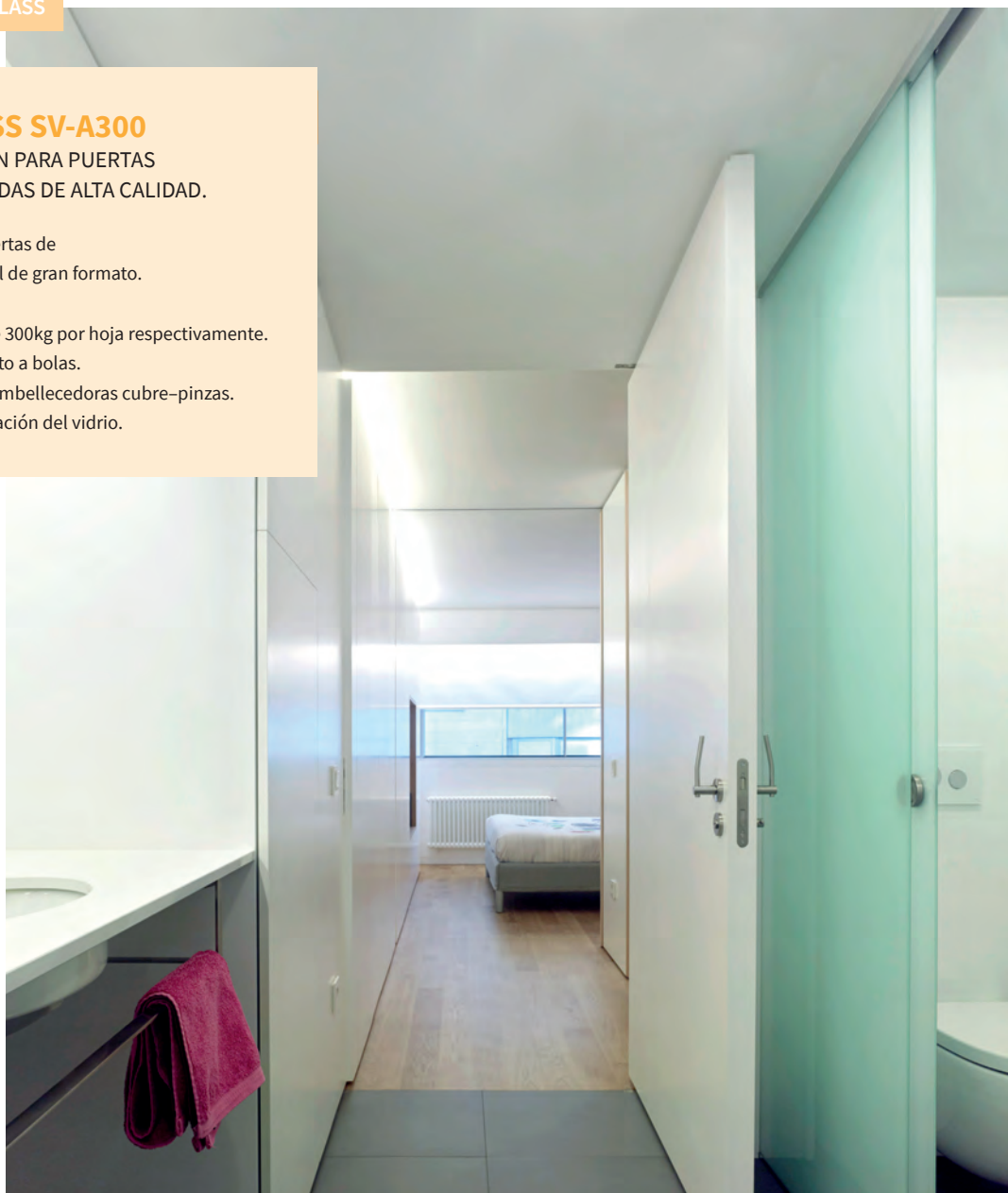

Características técnicas:

• Perfilaría:



20x20 mm



12x17 mm



20x15 mm



54x53 mm



10-12 mm



RODAMIENTO A BOLAS

• Especificaciones

• Producto certificado



• Peso

300 kg

VARIANTES DE INSTALACIÓN:

PUERTA CORREDERA

VIDRIO FIJO



SV-A300

SECCIÓN TIPO

MONTAJE A TECHO

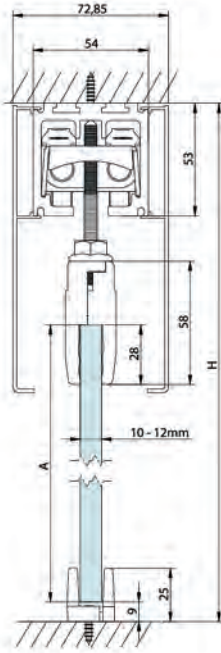

A= H-115

MONTAJE A TECHO
VIDRIO FIJO

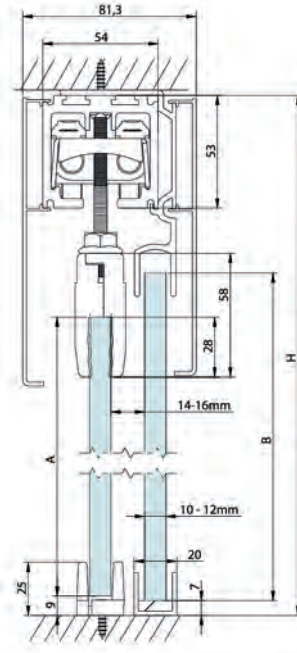

A= H-115 B= H-90

MONTAJE A PARED

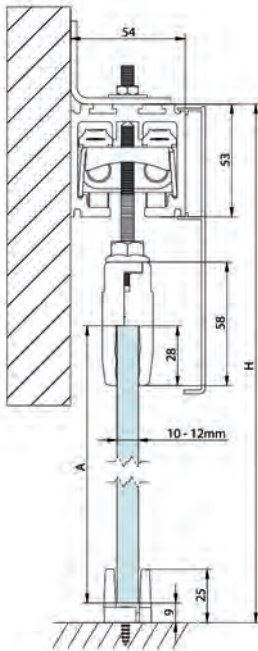

A= H-115

MONTAJE A PARED
VIDRIO FIJO

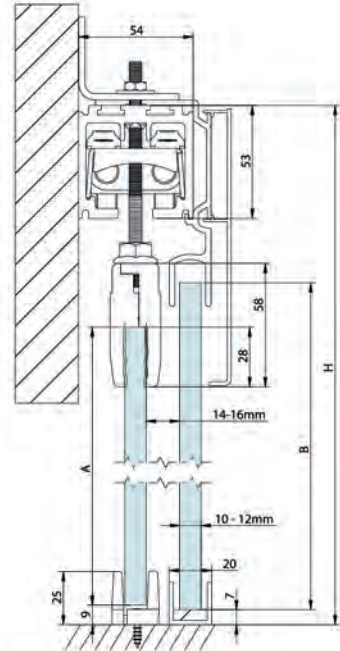

A= H-115 B= H-90



SV-A300

PERFILES

PERFIL SUPERIOR

Acabados:

3750 mm	Anodizado plata	2935.3 PL
4500 mm	Anodizado plata	2935.4 PL
6000 mm	Anodizado plata	2935.6 PL



256/37
256/45
256/60

EMBELLECEDOR FINAL DE PERFIL

Acabados:

Plata	2935.7 PL
-------	------------------



300/57



54x53 mm

PERFIL VIDRIO FIJO SV-A300

Acabados:

100 mm	Anodizado plata	2936.0 PL
2000 mm	Anodizado plata	2936.2 PL
3000 mm	Anodizado plata	2936.3 PL
5000 mm	Anodizado plata	2936.5 PL

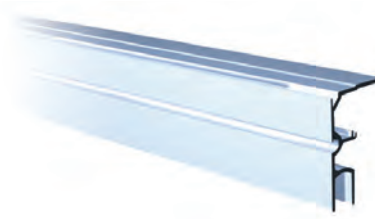

203/01
203/20
203/30
203/50



54x97 mm

PERFIL TAPA

Acabados:

3000 mm	Anodizado plata	2937.3 PL
5000 mm	Anodizado plata	2937.5 PL



204/30
204/50

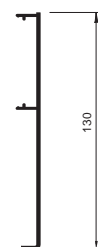

SV-A300

COMPONENTES

JUEGO COMPLETO DE ACCESORIOS SV-A300

Vidrio 10/12 mm

No compatible con softbrake

672.5



206/00

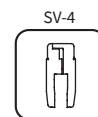

RODAMIENTO A BOLAS

GUIADOR INFERIOR

Vidrio 8/14 mm

Acabados:

Anodizado plata	2899 PL
Lacado negro	2899 NE
Lacado blanco	2899 BL

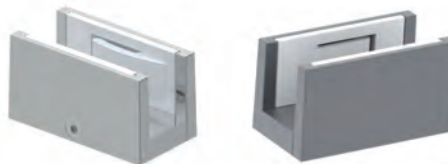

155/73

71/80

71/90

SOPORTE PARED

10 unidades cada 2000 mm

674

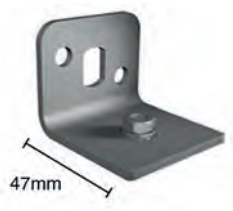

300/64

